

V 90.1-250 TV/G PRESS

AUTOMATIC TOTAL VACUUM PRESS



rev. 0020.1807.41

■ Press V 90.1-250 TV/G

- Continuous automatic total vacuum press
- Automatic dosing system
- Under vacuum dough preparation
- Extrusion screw in stainless steel with terminal at three principles
- Ø die 250 mm

V 90.1-250 TV/G PRESS

Press in stainless steel suitable for the production of dry and fresh pasta, particularly right for the automation of laboratory and small firms. It allows automatic production without worker presence.

Main technical features:

- Raw material premixer system Premix®
- Volumetric semolina measuring device and peristaltic pump fluid measuring device
- Vacuum kneading basin with pump, filter and vacuummeter
- Kneading paddles fixed without bolts to make easier the cleaning operations
- Sturdy thrust bearing group studied for long production duration
- Inverter for the electronic variation of the speed rotation of the screw extrusion
- Chiller for extrusion cylinder
- Horizontal die head with metal ring
- Safety manometer with electrical contacts
- Cutting group for the short pasta cut with inverter and set of knives at 1, 2, 4 blades
- Ventilation for short pasta cut

Optional:

- Electronic system ingredients dosing device with PLC with touch screen panel
- Penne cut device/cannelloni cut device
- Intermittent short pasta cut device
- Heating ventilation die



Optional: Premix®



Model v90 press coupled with DS model ravioli forming machine



Press V 90.1-250 TV/G



Model v90 press coupled with DS model ravioli forming machine

V 90.1-250 TV/G PRESS

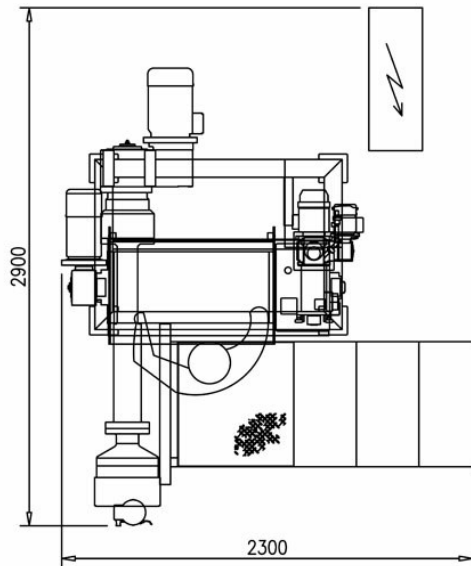
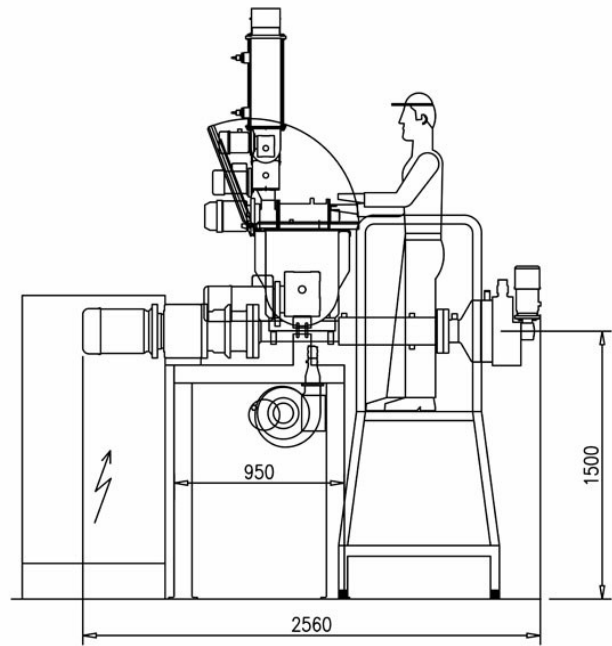
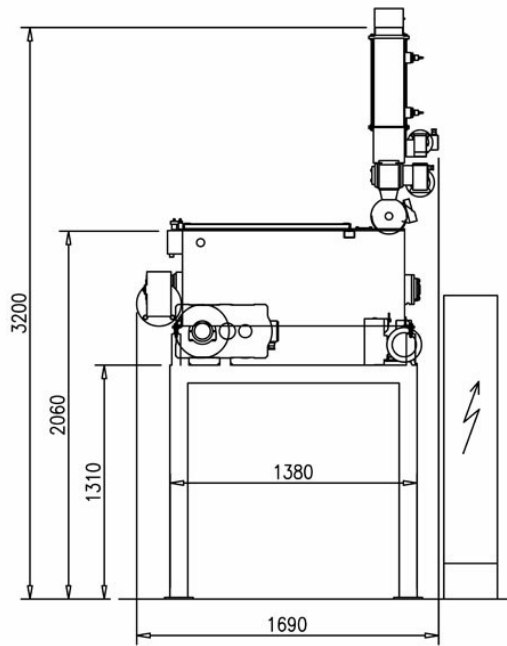

PRESS V90.1-250 TV/G	
Production (kg/h)	250-300
Power consumption (kW)	11
Installed power (kW)	12
Weight (kg)	800
Sizes (mm)	240x3112x2131
Mixing tank capacity (kg)	86.8 l (65kg)
Die dimension (mm)	250x234x60

Dimension and technical data are not binding. Storci S.p.A. reserves the right to modify them without notice.



facebook.com/storci.spa



youtube.com/user/StorciPastaMachinery



linkedin.com/company/storci-spa

Storci S.p.A.
via Lemignano, 6 - 43044 Collecchio (Parma)
phone: +39 0521 543611 fax: +39 0521 543621
www.storci.com - sales-storci@storci.com

